

TOSHIBA

E:ENGLISH

E

F:FRANÇAIS

F

S:ESPAÑOL

S

OWNER'S MANUAL

LCD TV

COLORSTREAM® SRS WOW

Introduction

Connecting
your TV

Using the
Remote Control

Setting up
your TV

Using the TV's
Features

Appendix

Index

14VL43U 20VL43U



Dear Customer,

Thank you for purchasing this Toshiba TV. This manual will help you use the many exciting features of your new TV.

Before operating the TV, please read this manual completely, and keep it nearby for future reference.

Safety Precautions

WARNING

TO REDUCE THE RISK OF FIRE OR ELECTRIC SHOCK, DO NOT EXPOSE THIS APPLIANCE TO RAIN OR MOISTURE.



WARNING: TO REDUCE THE RISK OF ELECTRIC SHOCK, DO NOT REMOVE COVER (OR BACK). NO USER-SERVICEABLE PARTS INSIDE. REFER SERVICING TO QUALIFIED SERVICE PERSONNEL.

 The lightning symbol in the triangle tells you that the voltage inside this product may be strong enough to cause an electric shock. **DO NOT TRY TO SERVICE THIS PRODUCT YOURSELF.**

 The exclamation mark in the triangle tells you that important operating and maintenance instructions follow this symbol.

CAUTION:

To reduce the risk of electric shock, do not use the polarized plug with an extension cord, receptacle, or other outlet unless the blades can be inserted completely to prevent blade exposure.

NOTE TO CATV INSTALLERS IN THE USA

This is a reminder to call the CATV system installer's attention to Article 820-40 of the NEC, which provides guidelines for proper grounding and, in particular, specifies that the cable ground shall be connected to the grounding system of the building, as close to the point of cable entry as practical. For additional antenna grounding information, see items 24 and 25 on page 4.

EXEMPTIONS

TACP/THI/TCL are not liable for:

- (1) damage caused by fire, earthquake, use by third party, accidents, owner's intentional misuse, or use in other improper conditions;
- (2) incidental damages (such as profit loss or interruption in business, modification or erasure of record data, and so forth) caused by use or misuse of this product;
- (3) damage caused by neglect of instructions described in the owner's manual; and
- (4) damage caused by misuse or malfunction through simultaneous use of this product and the connected equipment.

Child Safety

**It Makes A Difference
Where Your TV Stands**



Congratulations on your purchase! As you enjoy your new TV, keep these safety tips in mind:

The Issue

- If you are like most Americans, you have a TV in your home. Many homes, in fact, have more than one TV.
- The home theater entertainment experience is a growing trend, and larger TVs are popular purchases; however, they are not always supported on the proper TV stands.
- Sometimes TVs are improperly secured or inappropriately situated on dressers, bookcases, shelves, desks, audio speakers, chests, or carts. As a result, TVs may fall over, causing unnecessary injury.

Toshiba Cares!



- The consumer electronics industry is committed to making home entertainment enjoyable and safe.
- The Consumer Electronics Association formed the Home Entertainment Support Safety Committee, comprised of TV and consumer electronics furniture manufacturers, to advocate children's safety and educate consumers and their families about television safety.

Tune Into Safety

- One size does NOT fit all! Use appropriate furniture large enough to support the weight of your TV (and other electronic components).
- Use appropriate angle braces, straps, and anchors to secure your furniture to the wall (but never screw anything directly into the TV).
- Carefully read and understand the other enclosed instructions for proper use of this product.
- Do not allow children to climb on or play with furniture and TVs.
- Avoid placing any item on top of your TV (such as a VCR, remote control, or toy) that a curious child may reach for.
- Remember that children can become excited while watching a program and can potentially push or pull a TV over.
- Share our safety message about this hidden hazard of the home with your family and friends. Thank you!



2500 Wilson Blvd.
Arlington, VA 22201 U.S.A.
Tel. 703-907-7600 Fax 703-907-7690
www.CE.org

*CEA is the Sponsor, Producer and
Manager of the International CES®*

Important Safety Instructions

- 1) Read these instructions.
- 2) Keep these instructions.
- 3) Heed all warnings.
- 4) Follow all instructions.



- 5) Do not use this apparatus near water.



- 6) Clean only with dry cloth.

- 7) Do not block any ventilation openings. Install in accordance with the manufacturer's instructions.



- 8) Do not install near any heat sources such as radiators, heat registers, stoves, or other apparatus (including amplifiers) that produce heat.

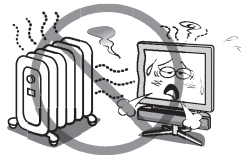

- 9) Do not defeat the safety purpose of the polarized or grounding type plug. A polarized plug has two blades with one wider than the other. A grounding type plug has two blades and a third grounding prong. The wide blade or the third prong are provided for your safety. If the provided plug does not fit into your outlet, consult an electrician for replacement of the obsolete outlet.

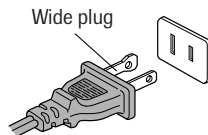

- 10) Protect the power cord from being walked on or pinched, particularly at plugs, convenience receptacles, and the point where it exits the apparatus.

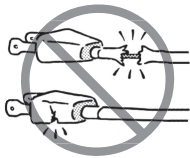

- 11) Only use attachments/accessories specified by the manufacturer.

- 12) Use only with the cart, stand, tripod, bracket, or table specified by the manufacturer, or sold with the apparatus. When a cart is used, use caution when moving the cart/apparatus combination to avoid injury from tip-over.



- 13) Unplug this apparatus during lightning storms or when unused for long periods of time.

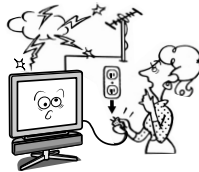

- 14) Refer all servicing to qualified service personnel. Servicing is required when the apparatus has been damaged in any way, such as power-supply cord or plug is damaged, liquid has been spilled or objects have fallen into the apparatus, the apparatus has been exposed to rain or moisture, does not operate normally, or has been dropped.



- 15) The apparatus shall not be exposed to dripping or splashing and that no objects filled with liquids, such as vases, shall be placed on the apparatus.

Installation, Care, and Service

Installation

Follow these recommendations and precautions and heed all warnings when installing your TV:

- 16) Never modify this equipment. Changes or modifications may void: a) the warranty, and b) the user's authority to operate this equipment under the rules of the Federal Communications Commission.

- 17) Never place or store the TV in direct sunlight; hot, humid areas; areas subject to excessive dust or vibration; or locations with temperatures at or below 41°F (5°C).



- 18) Always place the TV on the floor or a sturdy, level, stable surface that can support the weight of the unit.

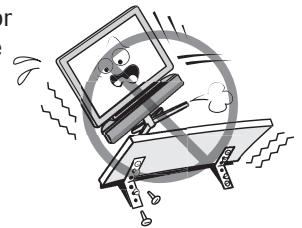

- 19) Never place items such as vases, aquariums, or candles on top of the TV.



- 20) Never block or cover the slots or openings in the TV cabinet back, bottom, and sides. Never place the TV:
 - on a bed, sofa, rug, or similar surface;
 - too close to drapes, curtains, or walls; or
 - in a confined space such as a bookcase, built-in cabinet, or any other place with poor ventilation.



The slots and openings are provided to protect the TV from overheating and to help maintain reliable operation of the TV.

- 21) Never allow anything to rest on or roll over the power cord, and never place the TV where the power cord is subject to wear or abuse.

- 22) Never overload wall outlets and extension cords.

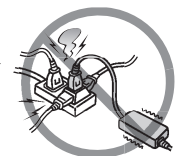

- 23) Always operate this equipment from a 110 - 220 VAC, 60 Hz power source only.

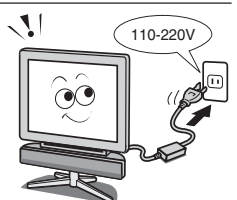

24) Always make sure the antenna system is properly grounded to provide adequate protection against voltage surges and built-up static charges (see Section 810 of the National Electric Code).

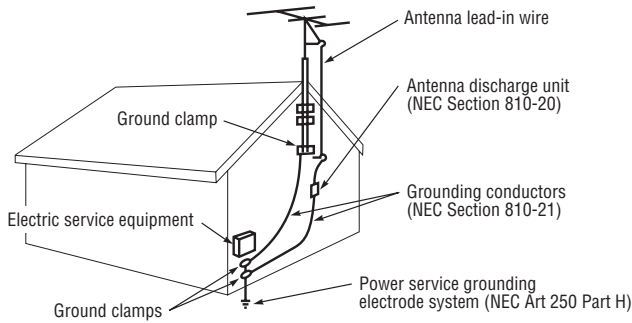

25) **! DANGER: RISK OF SERIOUS PERSONAL INJURY OR DEATH!**

- Use extreme care to make sure you are never in a position where your body (or any item you are in contact with, such as a ladder or screwdriver) can accidentally touch overhead power lines. Never locate the antenna near overhead power lines or other electrical circuits.
- Never attempt to install any of the following during lightning activity:
 - a) an antenna system; or b) cables, wires, or any home theater component connected to an antenna or phone system.

Care

For better performance and safer operation of your TOSHIBA TV, follow these recommendations and precautions:

26) Always unplug the TV before cleaning. Clean only with a dry cloth. Never use liquid or aerosol cleaners.

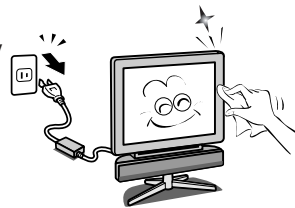

27) When dust has collected on the power plug, remove the plug and clean of the dust.

Do not hold the power cord only to remove the plug.
Do not touch the power plug with a wet hand.

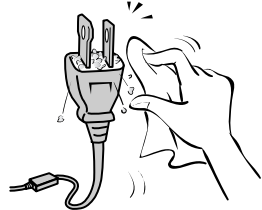

28) **! WARNING: RISK OF ELECTRIC SHOCK!** Never spill liquids or push objects of any kind into the TV cabinet slots.



29) For added protection of your TV from lightning and power surges, always unplug the power cord and disconnect the antenna from the TV if you leave the TV unattended or unused for long periods of time.

30) During normal use, the TV may make occasional snapping or popping sounds. This is normal, especially when the unit is being turned on or off. If these sounds become frequent or continuous, unplug the power cord and contact a Toshiba Authorized Service Center.



31) **! The screen on this TV is manufactured from glass.** To prevent damage, never strike the glass with a sharp or heavy object.



32) The liquid crystal display on this TV is manufactured using an extremely high level of precision technology; however, an occasional pixel (dot of light) may display constantly on the screen.

This is a structural property of LCD technology and is not a sign of malfunction.

Such pixels are not visible when the picture is viewed from a normal viewing distance.

Note: Interactive video games that involve shooting a "gun" type of joystick at on-screen target may not work on this TV.

Service

33) **! WARNING: RISK OF ELECTRIC SHOCK!** Never attempt to service the TV yourself. Opening and removing the covers may expose you to dangerous voltage or other hazards. Refer all servicing to a Toshiba Authorized Service Center.



34) If you have the TV serviced:

- Ask the service technician to use only replacement parts specified by the manufacturer.

- Upon completion of service, ask the service technician to perform routine safety checks to determine that the TV is in safe operating condition.



35) When the TV reaches the end of its useful life, ask a qualified service technician to properly dispose of the TV. Improper disposal may result in a picture tube implosion and possible personal injury.

Table of contents

E

F

S

Introduction	6	Using the TV's features	16
Welcome to Toshiba	6	Programming your favorite channels	16
Exploring your new TV	6	Using the V-CHIP feature	17
Selecting a location for the TV	7	Selecting a PIN code	17
Connecting the power cord and AC adaptor	7	Blocking programs by ratings	18
Connecting your TV	7	Changing your PIN code	20
Connecting a VCR	8	Adjusting the Picture	21
Connecting a cable converter box	8	Adjusting the picture quality	21
Connecting a cable converter box and a VCR	8	Using the blue screen feature	21
Connecting a DVD player or satellite receiver and a VCR	9	Selecting the video input source	22
Connecting a DVD player with ColorStream® (component video) and a VCR	10	Using the auto power off feature	22
Connecting a camcorder	11	Using the invert feature	22
Connecting an audio amplifier	11	Using the closed caption feature	23
Using the remote control	12	Setting the sleep timer	24
Learning about the Remote Control	12	Adjusting the Sound	24
Installing the remote control batteries	12	Muting the Sound	24
Setting up your TV	13	Adjusting the sound quality	24
Menu function	13	Selecting stereo/SAP broadcasts	25
Turning the TV On and Off	13	Using the WOW (sound effect) feature	26
Changing the on-screen display language	14	Displaying on-screen information	26
Programming channels into the TV's memory	14	Appendix	27
Programming channels automatically	14	Specifications	27
Adding and erasing channels manually	15	Troubleshooting	28
Changing channels	15	Limited United States Warranty	29
		Limited Canada Warranty	30
		Index	31

Introduction

Welcome to Toshiba

Congratulation! You have purchased one of the finest TFT LCD TV's on the market!

This manual will help you use the many exciting and useful features to make your TV viewing more enjoyable than before.

Before operating your TV set, please read all these safety and operating instructions completely and then retain for future reference.

Exploring your new TV

You can operate your TV by using the buttons on the Top panel or the remote control. The Side and back panels provide terminal inputs for connecting other equipment to your TV.

Customer's Record

You will find the model number and serial number on the back of your TV set.

Record these numbers in the spaces prided below.

Refer to them whenever you call upon your TOSHIBA dealer regarding this product.

Model Number _____

Serial Number _____

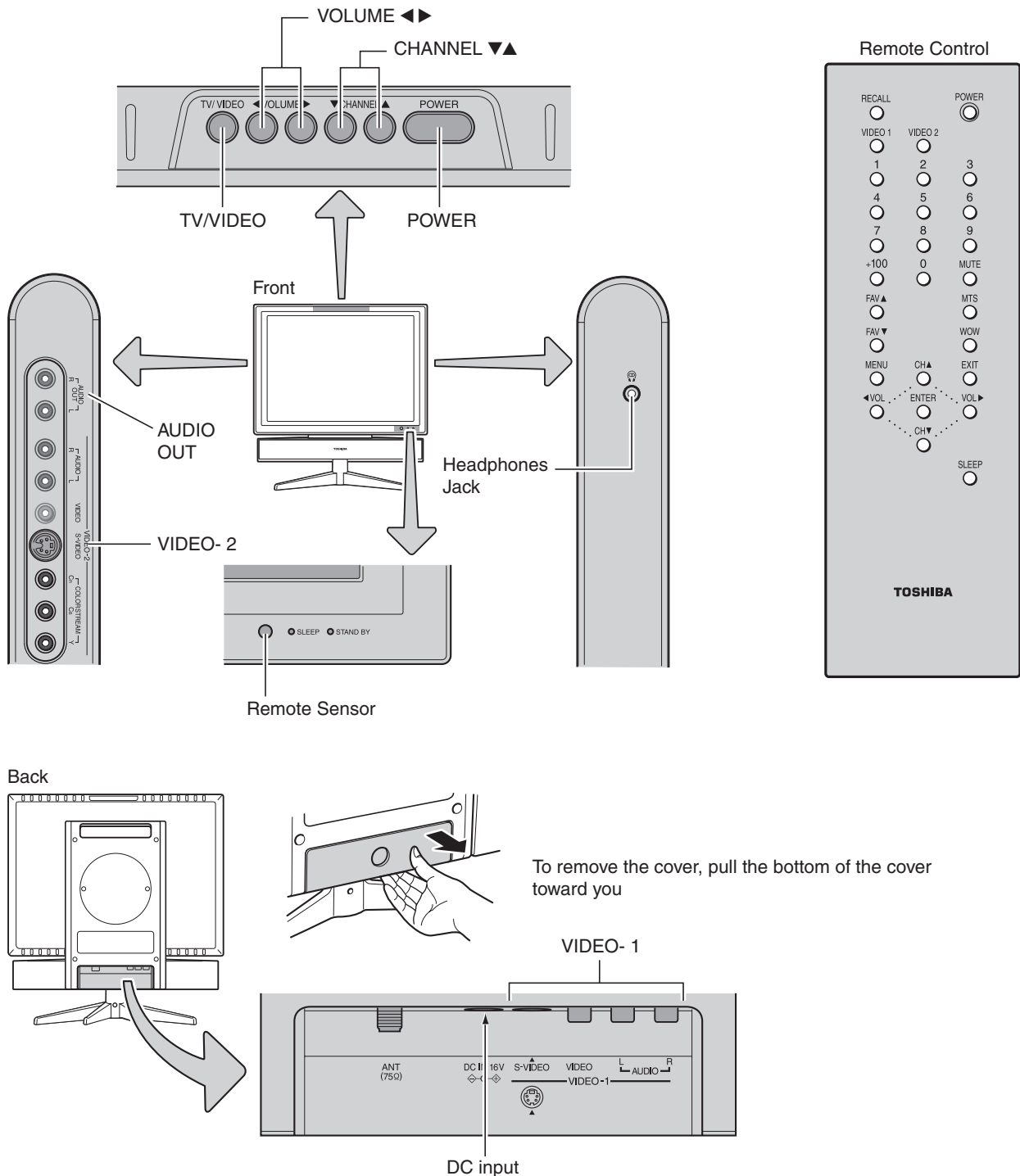

Selecting a location for the TV

Note: Before installing your TV, Please read the important safety information on pages 2-4.

- Place the TV on the floor or a sturdy, levels stable surface.
- Place the TV in a location where light does not directly hit the screen.
- Place the TV far enough from the walls to allow proper ventilation. Inadequate ventilation may cause overheating, which may damage the TV.

The LCD panel can be made to incline forward and backward.

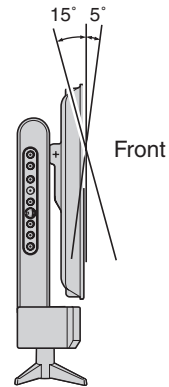

Connecting the power cord and AC adaptor

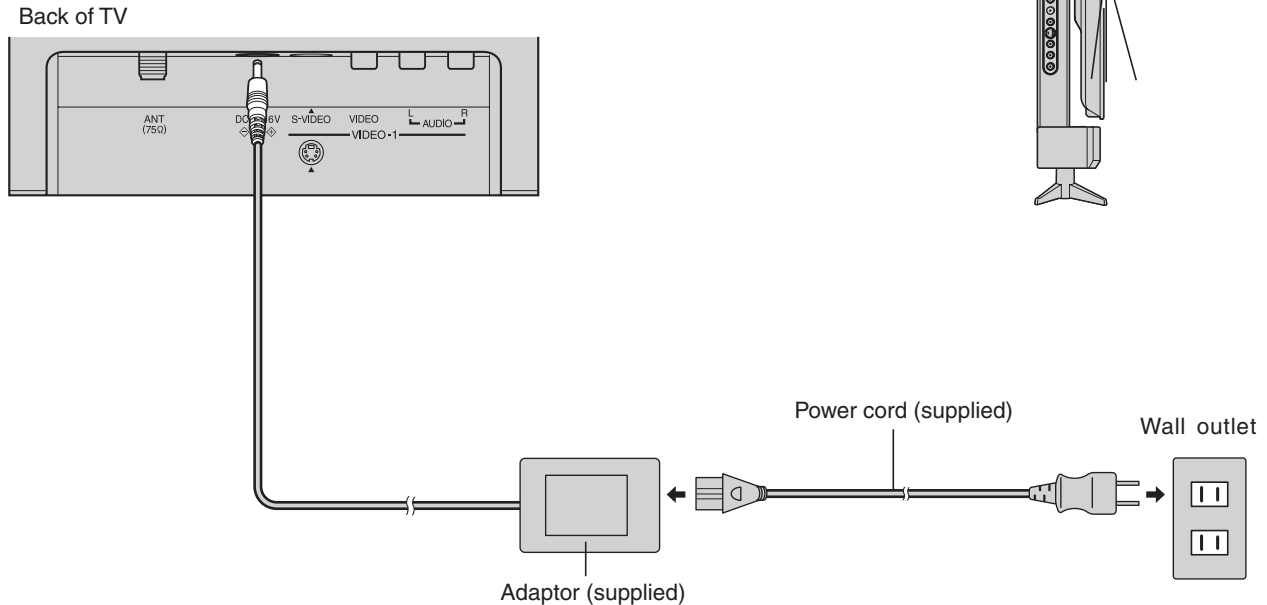

Connecting your TV

Note: Cables are not supplied with your TV.

- **Coaxial cable** is the cable that comes in from your antenna, cable TV service, or cable converter box. Coaxial cable uses “F” connectors.
- **Standard stereo A/V cables** usually come in sets of three, and are typically color-coded according to use: yellow for video, red for stereo right audio, and white for stereo left (or mono) audio. Your TV’s standard A/V inputs are color-coded in the same manner as the cables.
- **S-Video cable** is for use with video equipment that has S-Video connectors.
- **Component video cables** come in sets of three (typically color-coded red, green, and blue), and are for use with video equipment that has component video connectors. Your TV’s ColorStream® (component video) inputs are color-coded in the same manner as the cables.

NOTE REGARDING PICTURE QUALITY

When connecting video equipment to your Toshiba TV:

- **For GOOD picture quality:** Use a standard yellow video cable.
- **For BETTER picture quality:** If your equipment has S-video connectors, use an S-video cable *instead of* a standard yellow video cable. (You still must connect the standard red and white audio cables for full system connection, but *do not connect a standard yellow video cable at the same time* or the picture performance will be unacceptable.)
- **For BEST picture quality:** If your equipment has component video connectors, use component video cables *instead of* a standard yellow video cable or S-video cable. (You still must connect the standard red and white audio cables for full system connection.)

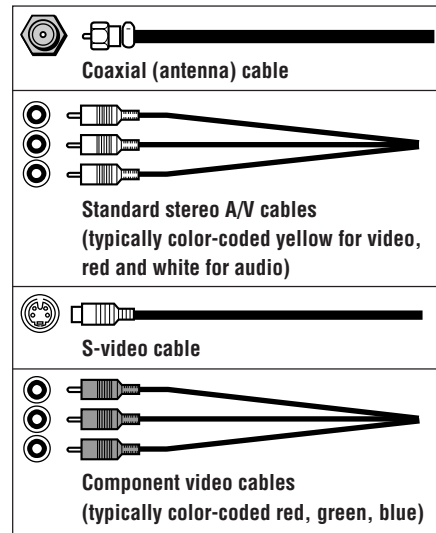

CAUTION:

Do not plug in any power cords until you have finished connecting all equipment.

Connecting a VCR

This connection allows you to watch local channels and video programs, play or record on the VCR while watching TV, and record from one channel while watching another channel.

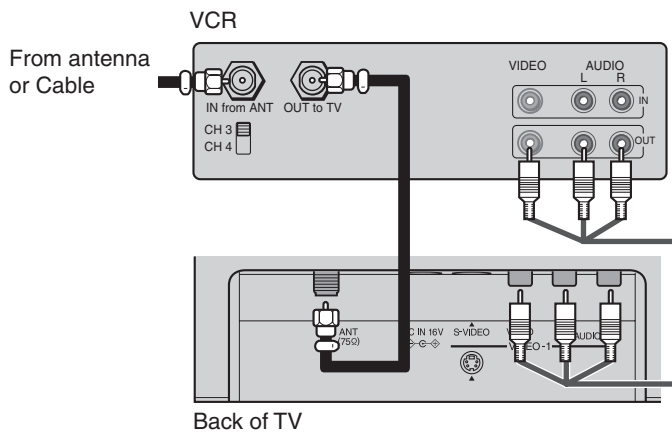

Note:

If you have a mono VCR, connect L/Mono to VCR Audio OUT using only one audio cable.

If you have an S-VHS VCR, use an S-video cable (in the S-video jacks) instead of the regular video cable.

Connecting a cable converter box

This connection allows you to watch basic and premium cable channels. Tune the TV to channel 3 or 4 (whichever channel is vacant in your area), and use the converter box to change channels.

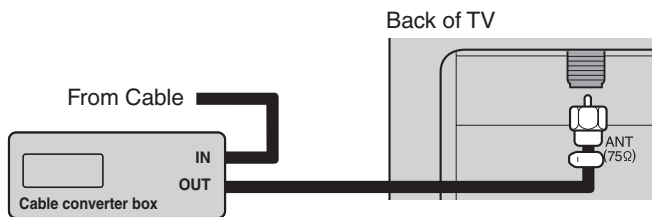

Note:

When you use a converter box with your TV, the channel selection feature does not operate.

Connecting a cable converter box and a VCR

This connection allows you to watch and record basic and premium cable channels, as well as watch videotapes. Set the TV signal source to VIDEO 1 (page 22). Tune the VCR to channel 3 or 4 (the same channel as the converter box output switch), and use the cable converter box to change channels.

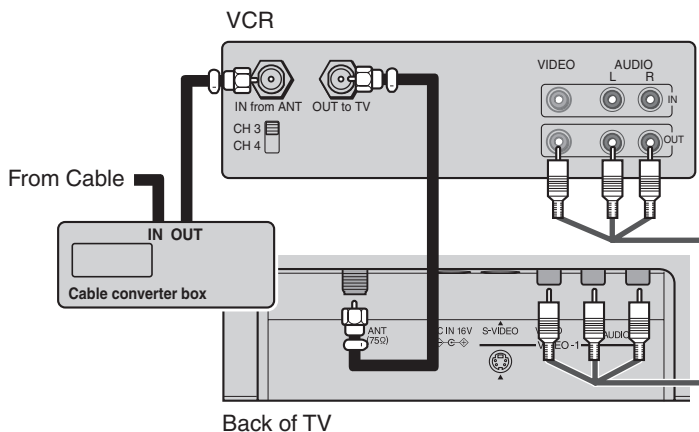

Note:

When you use a converter box with your TV, the channel selection feature does not operate.

If you have a mono VCR, connect L/Mono to VCR Audio OUT using only one audio cable.

If you have an S-VHS VCR, use an S-video cable instead of a standard video cable.

The TV side panel can be used to connect a VCR or other video equipment.

The unauthorized recording, use, distribution, or revision of television programs, videotapes, DVDs, and other materials is prohibited under the Copyright Laws of the United States and other countries, and may subject you to civil and criminal liability.

Connecting a DVD player or satellite receiver and a VCR

This connection allows you to watch DVD/satellite, VCR, or TV programs. You can record from the satellite receiver or TV. You can also record one TV channel while watching another channel.

Note: If your DVD player has component video connections, see "Connecting a DVD player with ColorStream® (component video) and a VCR on page 10.

You will need:

- one coaxial cable
- one set of A/V cable
- one pair of audio cables
- one S-video cable (between the TV and DVD player/satellite receiver)

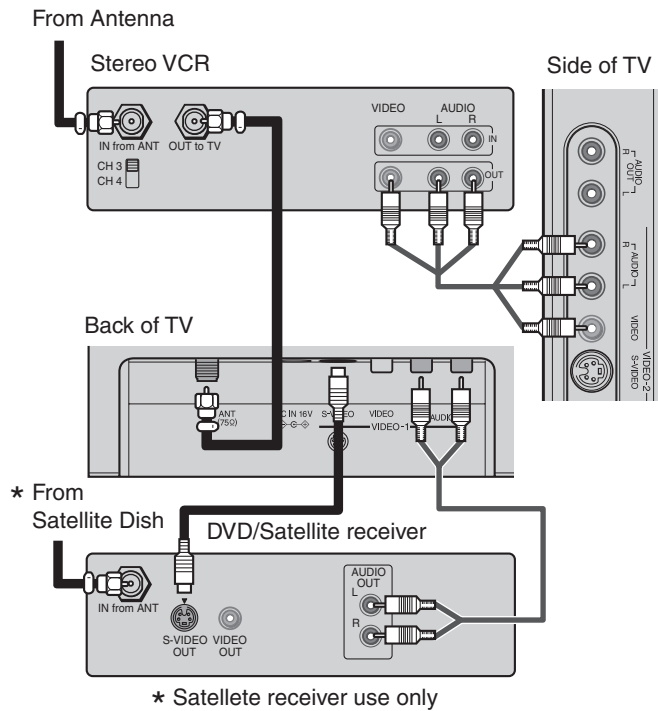

Note:

To watch a DVD /satellite program, the TV must select VIDEO 1; to watch a VCR program, the TV must select VIDEO 2 (see page 22).

You can use a standard video cable instead of an S-video cable between the TV and DVD player/satellite receiver, but the picture quality will decrease. The illustration at left shows one S-video cable and one pair of audio cables connected from the DVD player/satellite receiver to VIDEO 1 on the TV.

The unauthorized recording, use, distribution, or revision of television programs, videotapes, DVDs, and other materials is prohibited under the Copyright Laws of the United States and other countries, and may subject you to civil and criminal liability.

Connecting a DVD player with ColorStream® (component video) and a VCR

This connection allows you to watch DVD, VCR, or TV programs, and record TV programs. You can record one TV program while watching another TV program.

Your TV has ColorStream® (component video) connections. Connecting your TV to a component video compatible DVD player (such as Toshiba DVD player with ColorStream®) can greatly enhance picture quality and performance.

You will need:

- one coaxial cable
- one set of A/V cable
- one set of component video cables
- one pair of audio cables

Note:

For the best picture performance, use component video cables between the TV and DVD player. see "Note Regarding picture quality" on page 7.

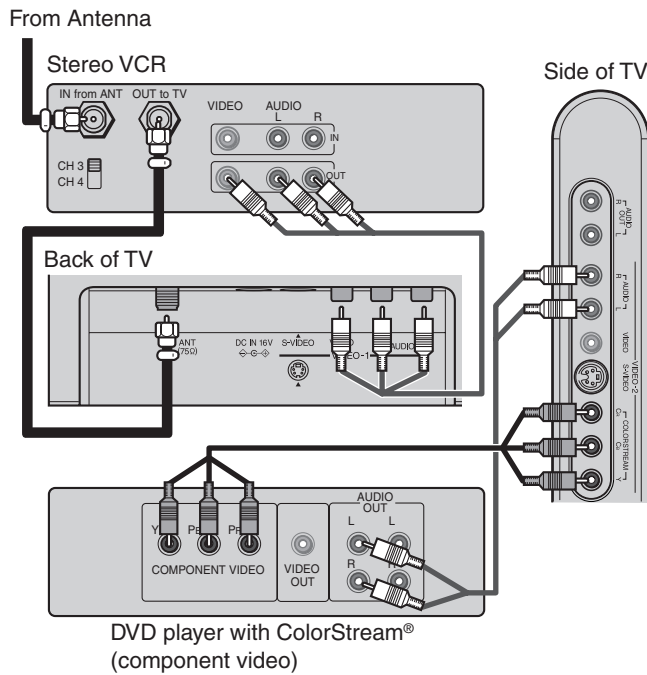

Connecting a camcorder

This connection allows you to watch video recorded on a camcorder.

You will need:

- one pairs of audio cables
- one video cable (or one S-video cable)

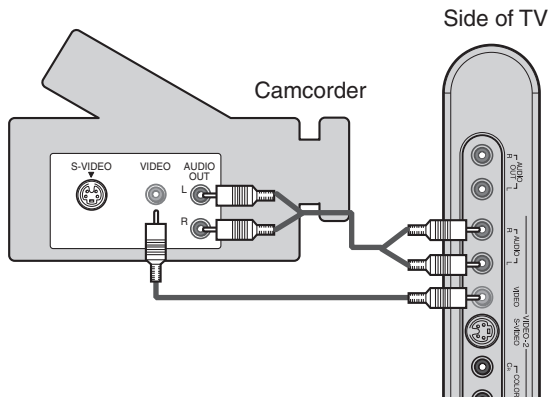

If your camcorder has an S- video connection, an S-video cable will provide better picture performance than a standard video cable.

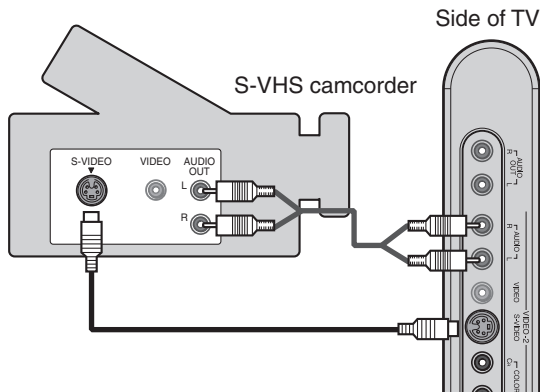

Connecting an audio amplifier

This connection allows you to use an audio amplifier to adjust the audio level. This connection also allows you to use external speakers.

You will need:

- one pair of audio cables

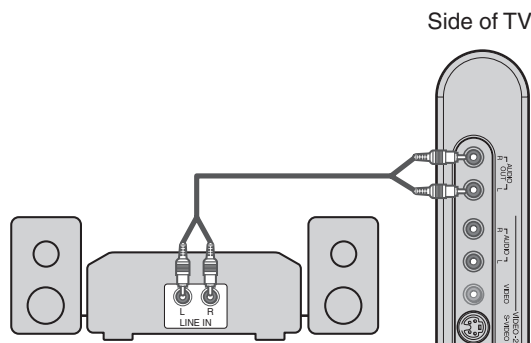

Note:

Do not connect a standard video cable and an S-video cable to VIDEO 1 (or VIDEO 2) at the same time, or the picture performance will be unacceptable.

Note:

To control the audio, both the TV and the amplifier must be turned on, and the volume of the amplifier must be set above 0, or you will not hear any sound.

Using the remote control

Learning about the Remote Control

RECALL displays screen information.

CHANNEL NUMBERS (0-9) allow direct access to channels.

+100 selects channels over 100.

POWER turns the TV on and off.

MUTE mutes the sound.

VIDEO1 selects video 1 mode.

VIDEO2 selects video 2 mode.

MENU allows access to programming menus.

ENTER sets programming menu information

SLEEP sets the TV to go off at a set time.

CH ▲ ▼ cycles through programmed channels. Also used to highlight selections on the on-screen menus.

VOL ◀ ▶ adjusts the volume level. Also used to increase or reduce the value of a menu option.

FAV ▲ ▼ cycles through favorite channels.

MTS switches MTS (stereo or SAP) sound.

WOW switches sound effect on and off.

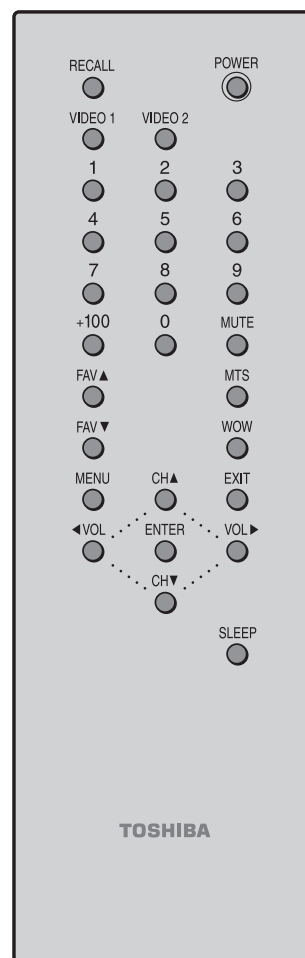

Installing the remote control batteries

To install the batteries:

1. Slide the battery cover off the back of the remote control.
2. Install two “AAA” size alkaline batteries. Match the + and – signs on the batteries to the signs on the battery compartment.

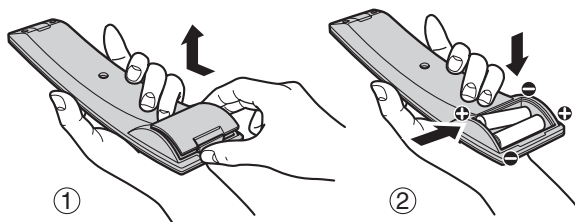

3. Slide the battery cover back on to the remote control until the lock snaps.
 - You can use your remote control within a distance of 5m and an angle of 30 degrees from the left and right sides of the remote sensor of your TV.

Caution:

- Dispose of batteries in a designated disposal area. Do not throw batteries into a fire.
- Do not mix battery types or combine used batteries with new ones.
- Remove dead batteries immediately to prevent battery acid from leaking into the battery compartment.

Note:

- If you do not intend to use the remote control for a long time, remove the batteries.
- If the remote control does not operate correctly, or if the operating range becomes reduced, replace both batteries with new ones.

Setting up your TV

Menu function

After you have installed the batteries, you will need to set some preferences on the TV using the menu system. You can access the menus using the buttons on your TV or remote control.

1. Press **MENU** to display menu.
2. Press **◀** or **▶** to select menu.
3. Press **▲** or **▼** select an item.
4. Press **◀** or **▶** to select or adjust a setting.

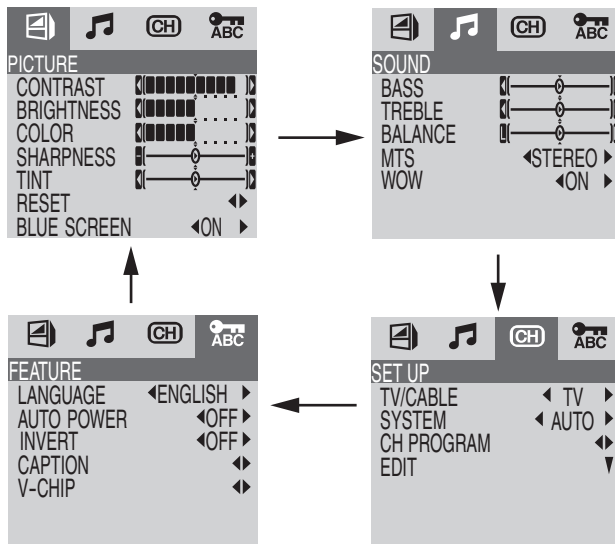

- Press **ENTER** to activate the function settings in the menus.
- The main menu display will disappear automatically if you do not make a selection within 30 seconds. If you want to close all the on-screen displays instantly, press **EXIT**.

Turning the TV On and Off

1. Press the **POWER** button on the TV or on the remote control. The **POWER** indicator will light up in green and the picture will appear.
2. To turn off the TV, press the **POWER** button again, the **POWER** indicator will light up in red (standby).

Note:

If you leave the TV unattended or unused for long periods of time, unplug the power cord.

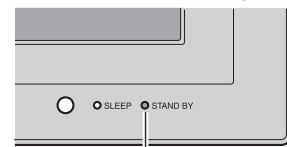
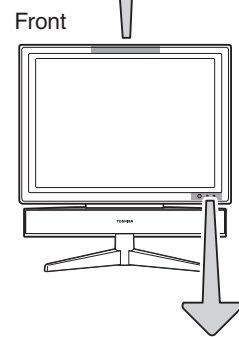
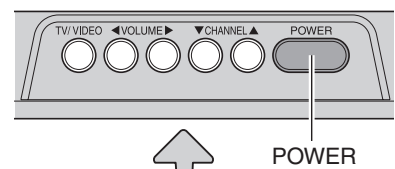
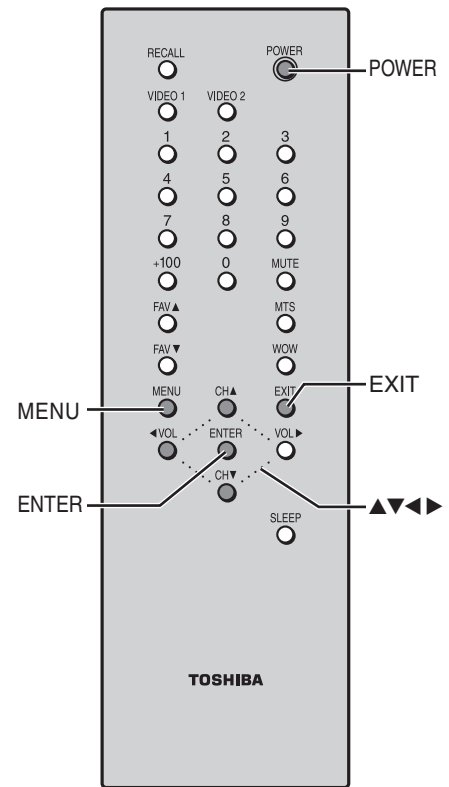

POWER indicator
Green- ON
Red- standby

Changing the on-screen display language

Choose from three different languages (English, French and Spanish) for the on-screen display of adjustment menus and messages.

To select a language:

1. Press **MENU**, and then press ◀ or ▶ to display the **FEATURE** menu appears.
2. Press ▲ or ▼ to highlight **LANGUAGE**.

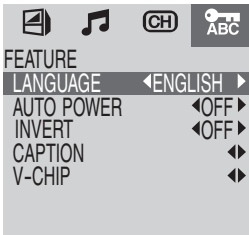

3. Press ◀ or ▶ to select your desired language.

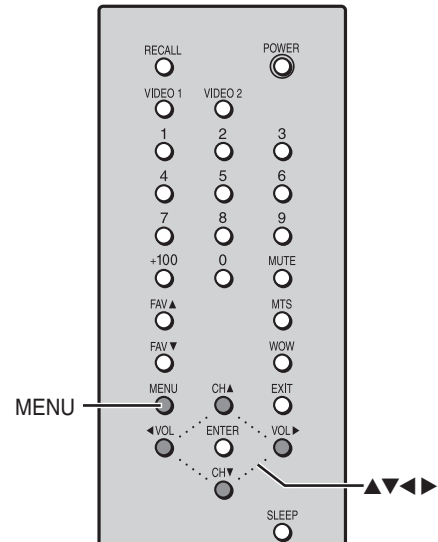

Programming channels into the TV's memory

When you press **CHANNEL** ▲ ▼ on the TV or remote control, the TV stops only on the channels stored in the TV's memory.

Note: To tune the TV to a channel not programmed into the channel memory, use the **CHANNEL NUMBERS** on the remote control.

Follow the steps below and on the next page to program channels into the TV's memory.

Programming channels automatically

Your TV can automatically detect all active channels in your area and store them in the TV's memory. After the channels are stored automatically, you can manually add or erase individual channels (see page 15).

To program channels automatically:

1. Press **MENU**, and then press ◀ or ▶ to display the **SET UP** menu.
2. Press ▲ or ▼ to highlight **TV/CABLE**.
3. Press ◀ or ▶ to select **TV** (if you use an antenna) or **CABLE** (if you use Cable).
4. Press ▼ to highlight **SYSTEM**.
5. Press ◀ or ▶ to select the correct color system.
AUTO, NTSC- M, PAL- M and PAL- N will appear cyclically.
Normally select **AUTO**.

This selection is necessary only when the color of a certain channel is abnormal.

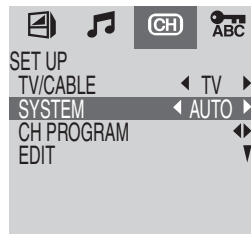
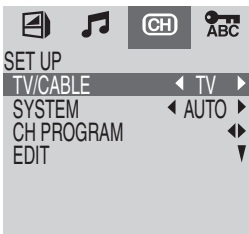

6. Press ▼ to highlight **CH PROGRAM**.

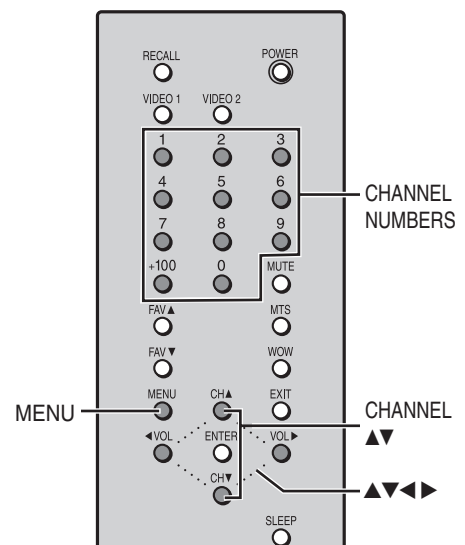

[Continued on the next page]

- Press ◀ or ▶ to start automatically channel programming (CH PROGRAM window appears on-screen). The TV automatically cycles through every TV or cable channel (depending on which you selected), and stores all active channels in the TV's memory. Press **MENU** to stop on the way.



- When the CH PROGRAM window disappears, the channel programming is complete.
- Press **CHANNEL ▲ ▼** to view the programmed channels.

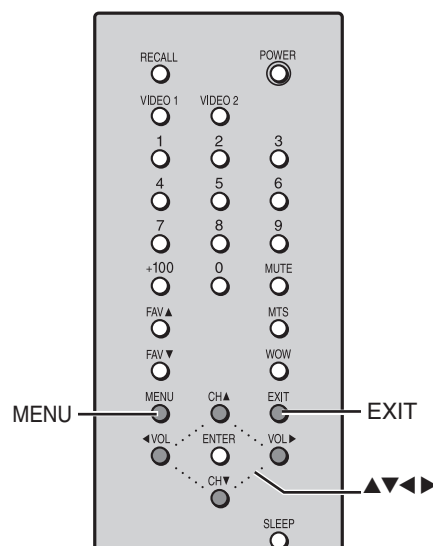

Adding and erasing channels manually

After you have automatically programmed the channels into the TV's memory, you can manually add and erase individual channels.

To add a channel to or erase a channel from the TV's memory:

- Press **MENU**, and then press ◀ or ▶ to display the SET UP menu.
- Press ▲ or ▼ to highlight EDIT, and then press ▼ to display the EDIT menu.
- Press ▲ or ▼ to highlight CH POSITION.
- Press ◀ or ▶ to select the channel you want to add or erase.

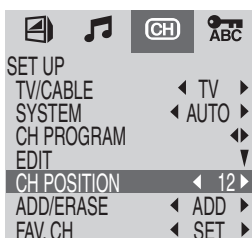

- Press ▼ to highlight ADD / ERASE.
- Press ◀ or ▶ to select ADD or ERASE, whichever function you want to perform.

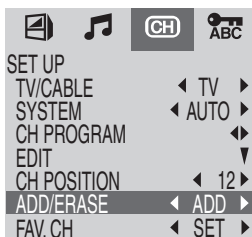

- Repeat steps 3-6 for other channels you want to add or erase, or press **EXIT** to return to normal TV viewing.

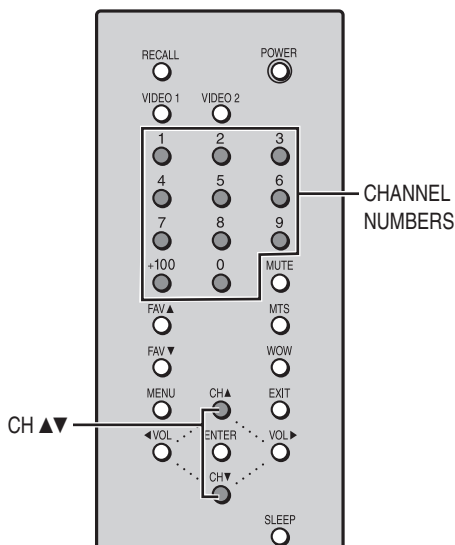

Changing channels

To change to the next programmed channel:

Press **CHANNEL (CH) ▲ ▼**.

To change to a specific channel (programmed or unprogrammed):

Press the **CHANNEL NUMBERS** (0–9 and 100).

Note: For channels +100 and higher, press the +100 button, and then the next two channel numbers (for example, to select channel 100, press +100,0,0; to select channel 125, press +100, 2, 5).

Note:

If V-Chip blocking is enabled when you change channels exceeding the rating limits will appear as a black screen with the message. See "Using the V-CHIP feature" on page 17.

Example

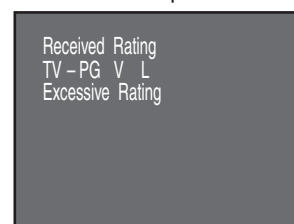

Using the TV's features

Programming your favorite channels

The favorite channel feature allow you to use the **FAV ▲▼** buttons on the remote control to cycle through your favorite channels, skipping over channels you do not normally watch. You can program a maximum of 12 favorite channels.

Note: You can still use **CHANNEL (CH) ▲▼** to cycle through all the channels you previously programmed into the TV's memory (see "Programming channels into the TV's memory" on page 14).

To Program your favorite channels:

1. Press **MENU**, and then press **◀** or **▶** to display the SET UP menu.
2. Press **▲** or **▼** to highlight EDIT, and then press **▼** to display the edit menu.
3. Press **▼** to highlight CH POSITION.

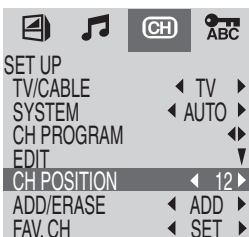

4. Press **◀** or **▶** to select a channel you want to program as a favorite channel.
5. Press **▼** to highlight FAV.CH.

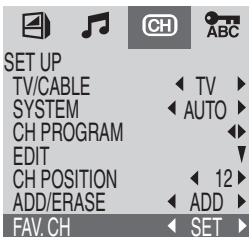

6. Press **◀** or **▶** to select SET.
7. Repeat steps 3-6 for up to 12 channels.
8. Press **EXIT**.

To select your favorite channels:

Press **FAV ▲** or **▼** on the remote control to cycle through the favorite channels you programmed.

Note: The **FAV ▲▼** buttons will not work unless you program at least one favorite channel.

To clear a favorite channel:

Select CLEAR in step 6 above.

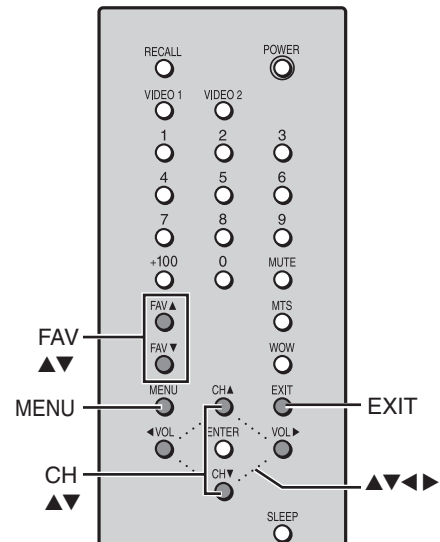

Using the V-CHIP feature

You can use the V-Chip feature to block certain programs or channels, to prevent others from viewing them.

Selecting a PIN code

Before you can block programs or channels, you must select a personal identification number (PIN) code. Your PIN code allows you to access the V-Chip menu, and prevents others from changing the rating and blocking limits you set.

To select PIN code and access the V-Chip menu:

1. Press **MENU**, and then press ◀ or ▶ to display the FEATURE menu.
2. Press ▲ or ▼ to highlight V-CHIP.
3. Press ◀ or ▶ to display the PIN code entering screen.

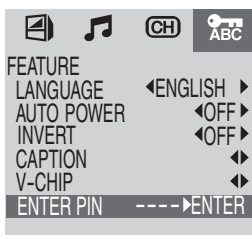
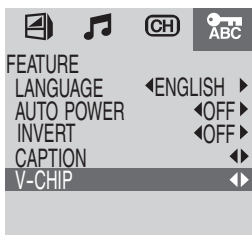

4. Use the **NUMBERS** (0–9) to enter your four – digit PIN code. After the code is entered, the V-Chip menu appears.

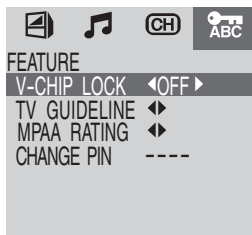
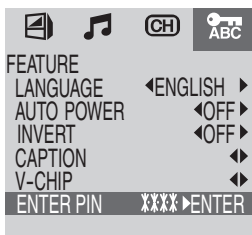

- When the PIN code is already stored.

If the wrong PIN code is entered, the following message will appear.



Enter the code again, and then press **ENTER**.

5. Press ▲ or ▼ to highlight V-CHIP LOCK.

6. Press ◀ or ▶ to select "ON" which enables all blocking by activating the V-Chip. (Select "OFF" to deactivate the V-Chip feature and disable blocking.)

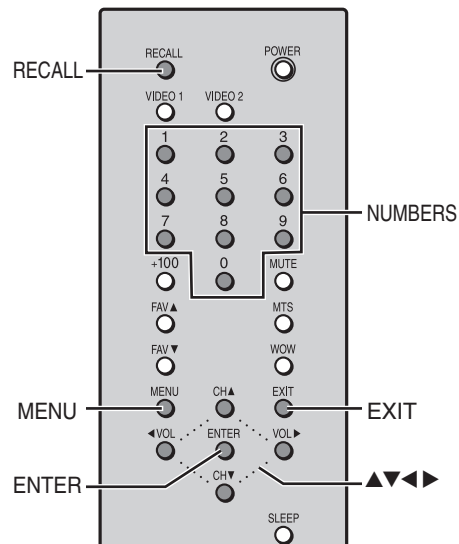
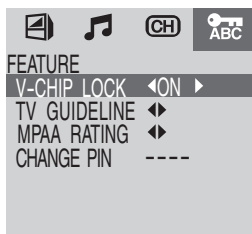

Note:

The default PIN number for new TV set is "0-0-0-0."

If you forget your PIN code

1. Press **MENU**, and then press ◀ or ▶ to display the FEATURE menu.
2. Press ▲ or ▼ to highlight V-CHIP.
3. Press ◀ or ▶ to display the PIN code entering screen.
4. While the PIN code entering screen is displayed, press **RECALL** four times within five seconds to reset the PIN code.
5. Press the default PIN number "0,0,0 and 0."
6. Press **EXIT** to return to normal TV viewing.

Blocking programs by ratings

The Motion Picture Association of America (MPAA) uses a rating system to qualify motion picture content. Television broadcasters employ a similar rating system to qualify the content of television programs.

The TV and MPAA ratings work with the V-Chip feature to allow you to block access to programs that exceed the rating limits you set.

Ratings definitions	
TV Ratings	
Y7, Y7FV	Directed to older children. Programs rated Y7 are designed for children 7 and above. Programs rated Y7FV contain fantasy violence that may be more intense or combative than Y7- rated programs.
Y	For all children. Programs rated Y are designed to be appropriate for all children.
MA	Mature audience only. This program is specifically designed to be viewed by adults and therefore may be unsuitable for children under 17. Dialog Intensely suggestive dialog Language Crude or indecent language Sex Explicit sexual activity Violence Graphic violence
14	Parents strongly cautioned. This program contains some material that many parents would find unsuitable for children under 14 years of age. Dialog Frequent suggestive dialog Language Frequent coarse language Sex Intense sexual situations Violence Intense violence
PG	Parental guidance suggested. This program contains material that parents may find unsuitable for younger children. Dialog Some suggestive dialog Language Occasional coarse language Sex Some sexual situations Violence Moderate violence
G	General audience. Most parents would find this program suitable for all ages.
MPAA Ratings	
NR	Not rated.
X	For adults only
NC17	Not intended for anyone 17 or under.
R	Restricted. Under 17 requires an accompanying parent or adult guardian.
PG13	Parents strongly cautioned. Some material may not be appropriate for children under 13.
PG	Parental guidance suggested. Some material may not be appropriate for children.
G	General audience. Appropriate for all ages.

To block programs by TV rating:

1. Press **MENU**, and then press ◀ or ▶ to display the FEATURE menu.
2. Press ▲ or ▼ to highlight V-CHIP.
3. Press ◀ or ▶ to display the PIN code entering screen.
4. Use the **NUMBERS** (0–9) to enter your four – digit PIN code. After the code is entered, the V-Chip menu appears.
5. Press ▲ or ▼ to highlight V-CHIP LOCK select ON.

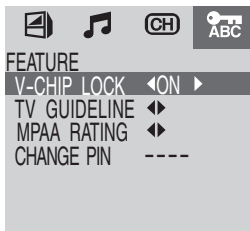

6. Press ▲ or ▼ to highlight TV GUIDELINE.
7. Press ◀ or ▶ to display the TV Rating menu.

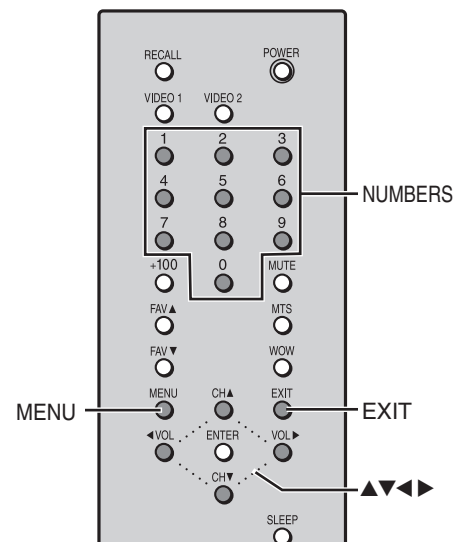

[Continued on the next page]

- Press ▲ or ▼ to select one of the six age- based categories.

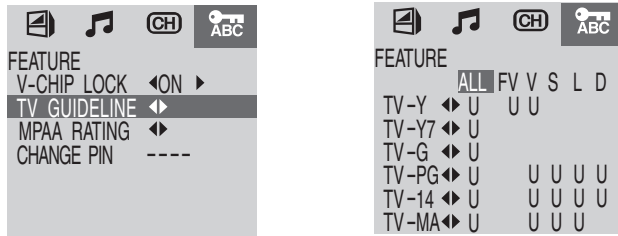

- Press ► to highlight “ALL” or sub-ratings (FV,V,S,L or D).
- Press ▲ or ▼ to select (or deselect) the ratings to be blocked. Blocked rating will be marked with “B”; unblocked ratings will be marked with “U”.
- Press ◀ to highlight ◀▶, and then press ▲ or ▼ to highlight a different category.
- Repeat steps 9 and 10.
- To return to normal TV viewing, press **EXIT**.

To block programs by MPAA rating:

The MPAA Rating system uses the Motion Picture Association of America (MPAA) system, and its main application is for movies. (Eventually, movie videocassettes will be encoded with MPAA ratings.) When the V-Chip Lock is on, the TV will automatically block any programs that are coded with objectionable ratings (either MPAA or TV- Ratings).

- Press **MENU**, and then press ◀ or ▶ to display the **FEATURE** menu.
- Press ▲ or ▼ to highlight **V-CHIP**, and then press ◀ or ▶ to display the PIN code entering screen.
- Enter your four – digit PIN code. The V-Chip menu appears.
- Press ▲ or ▼ to highlight **V-CHIP LOCK**, and then press ◀ or ▶ to select “ON”.
- Press ▲ or ▼ to highlight **MPAA RATING**, and then press ◀ or ▶ to display the MPAA Rating menu.

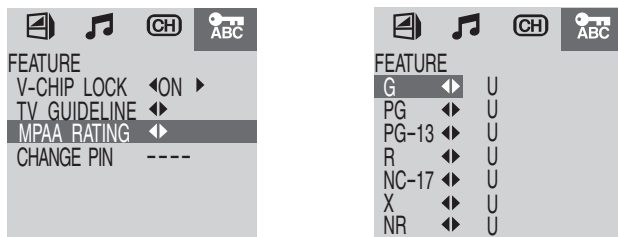

- Press ▲ or ▼ to highlight a particular MPAA categories, and then press ◀ or ▶ to activate it.
- Press ▲ or ▼ to select (or deselect) the ratings to be blocked. Blocked rating will be marked with “B”; unblocked ratings will be marked with “U”.
- Press ◀, and repeat steps 6 and 7 to set a different MPAA rating category.

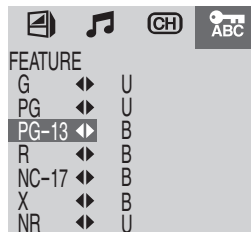

Notes:

- The V-Chip will automatically block certain categories that are “more restrictive”.

For example, if you block “TV-Y” category, then TV-Y7 will automatically be blocked. Similarly, if you block the TV-G category, then all the categories in the “young adult” group will be blocked (TVG, TV-PG, TV-14 and TV-MA).

The sub-ratings (D, L, S, V) work together similarly. (See “Ratings definitions on page 18.)

- The V-Chip will automatically block certain categories that are “More restrictive”.

For example, if you block “L” sub-rating in TV-PG, then the “L” sub-ratings in TV-14 and TV-MA will automatically be blocked.

Changing your PIN code

1. Press **MENU**, and then press ◀ or ▶ to display the FEATURE menu.
2. Press ▲ or ▼ to highlight V-CHIP.
3. Press ◀ or ▶ to display the PIN code entering screen.
4. Use the **NUMBERS(0–9)** to enter your existing PIN code. After the code is entered, the V-Chip menu appears.
5. Press ▲ or ▼ to highlight CHANGE PIN.

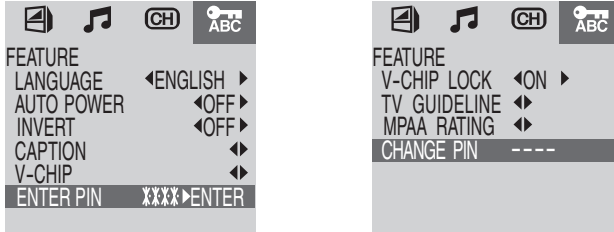

6. Use the **NUMBERS(0–9)** to enter a new PIN code. After the new code is entered, the CONFIRM PIN appears.

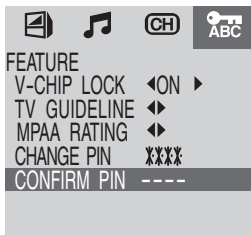

7. Reenter the new PIN code.

Press **EXIT** to return to normal TV viewing.

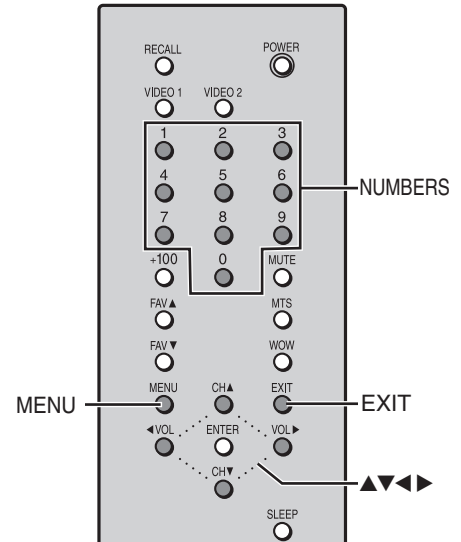

Adjusting the Picture

Adjusting the picture quality

You can adjust the picture quality to your personal preferences, including the contrast, brightness, sharpness, color, and tint. The qualities you choose will be stored automatically in your TV's memory.

To adjust the picture quality:

1. Press **MENU**, and then press ◀ or ▶ to display the PICTURE menu.
2. Press ▲ or ▼ to highlight the PICTURE item you want to adjust.
3. Press ◀ or ▶ to adjust the level.

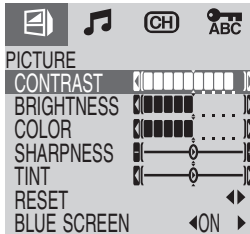

The PICTURE items you have adjusted will be stored in the TV's memory automatically.

Selection	◀ Pressing	▶
Contrast	lower	higher
Brightness	darker	lighter
Color	paler	deeper
Sharpness	softer	sharper
Tint	greenish	reddish

Using the blue screen feature

With the blue screen function ON, the screen will automatically turn blue and the sound will be muted when no signal is received.

To turn on the blue screen:

1. Press **MENU**, and then press ◀ or ▶ to display the PICTURE menu.
2. Press ▲ or ▼ to highlight BLUE SCREEN, and then press ◀ or ▶ to select "ON".

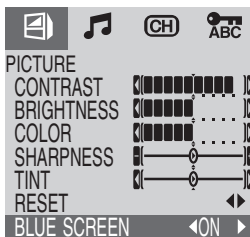

Note:

If the blue screen tends to mis-operate due to unstable signal strength or frequency, select "OFF" in step 2.

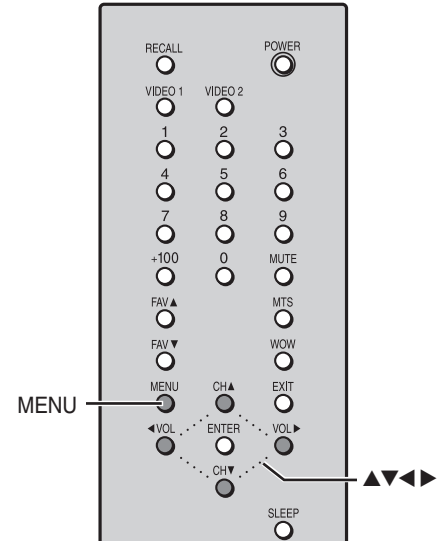

Note:

To reset the picture adjustments to the factory-preset status.

(Contrast maximum and all other adjustments centered.)

1. Press **MENU**, and then press ◀ or ▶ to display the PICTURE menu.
2. Press ▲ or ▼ to highlight RESET, and then press ◀ or ▶.

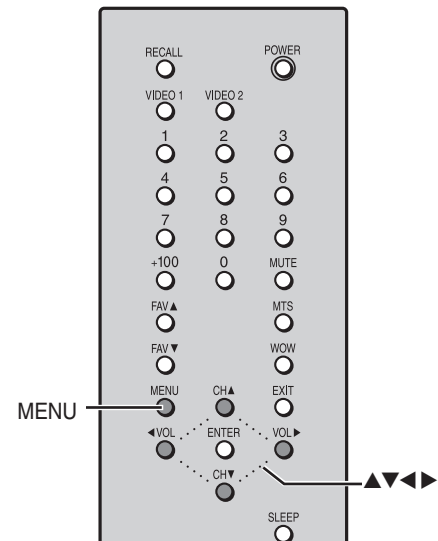

Selecting the video input source

You can use the **VIDEO1** or **VIDEO 2** buttons on the remote control to view a signal coming from other devices, such as VCRs or video disc players that may be connected to your TV. (see “Connecting your TV” on page 8.)

Or press the **TV/VIDEO** button on the TV repeatedly to select VIDEO1, VIDEO2 or TV.

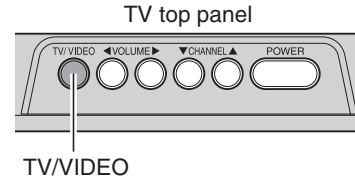

Using the auto power off feature

The TV will automatically turn itself off (standby mode) after approximately 15 minutes if it is tuned to a vacant channel or a station that completes its broadcast for the day. This feature does not work in VIDEO mode.

To turn on the auto power off feature:

1. Press **MENU**, and then press ◀ or ▶ to display the **FEATURE** menu.
2. Press ▲ or ▼ to highlight **AUTO POWER**, and then press ◀ or ▶ to select “ON”.

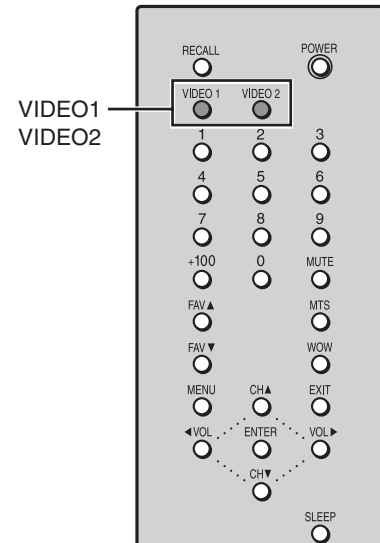
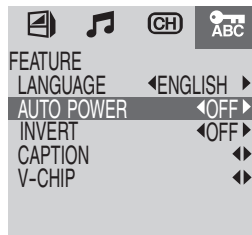

To turn off the auto power off feature:

Select “OFF” in step 2.

Using the invert feature

This is a function to invert the on-screen menu.

To select the invert mode:

1. Press **MENU**, and then press ◀ or ▶ to display the **FEATURE** menu.
2. Press ▲ or ▼ to highlight **INVERT**, and then press ◀ or ▶ to select the desired invert mode.

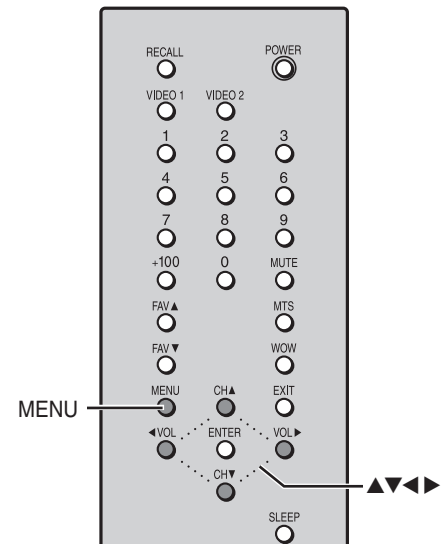
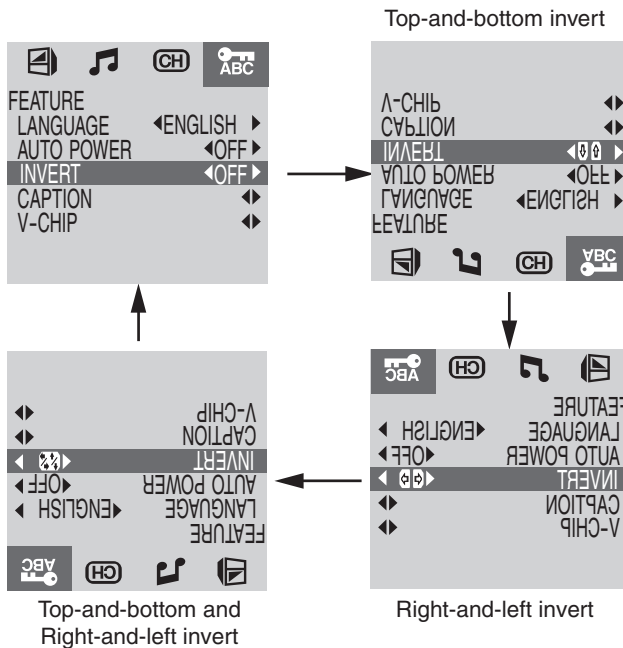

Using the closed caption feature

The closed caption feature has two options:

- **Captions**—An on-screen display of the dialogue, narration, and sound effects of TV programs and videos that are closed captioned (usually marked as “CC” in TV listings).
- **Text**—An on-screen display of information not related to the current program, such as weather or stock data (when provided by individual stations).

To view captions or text:

1. Tune the TV to the desired program.
2. Press **MENU**, and then press ◀ or ▶ to display the FEATURE menu.
3. Press ▲ or ▼ to highlight CAPTION.
4. Press ◀ or ▶ to display CAPTION menu, and then press ◀ or ▶ to select closed caption “ON” or “OFF”.

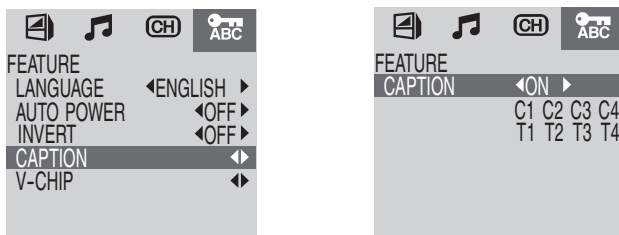

5. Press ▲, ▼, ◀ or ▶ to highlight the desired closed caption mode, as follows:
 - To view captions, highlight C1, C2, C3, or C4 (C1 displays translation of the primary language in your area).

Note: If the program or video you selected is not closed captioned, no captions will display on the screen.



- To view text, highlight T1, T2, T3, or T4.

Note: If text is not available in your area, a black rectangle may appear on your screen. If this happens, turn the Closed Caption feature OFF.

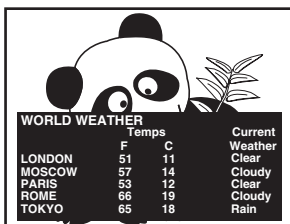

To turn off the Closed Caption feature:

Select OFF in step 4.

Note:

A closed caption signal may not display in the following situations:

- when a videotape has been dubbed
- when the signal reception is weak
- when the signal reception is nonstandard

When “ON” mode is selected, the last selected caption or text mode is selected.

At this time, C1-T4 are not highlighted.

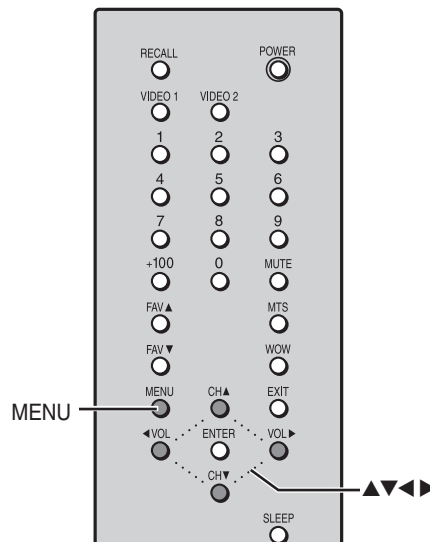

Setting the sleep timer

To set the sleep timer to turn the TV off (standby mode) automatically:

1. Press **SLEEP** to set the length of time until the TV turns off.

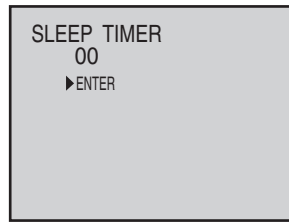

Every time you press the button, the time display will decrease by 30 minutes.

180 → 150 → 120 → 90 → 60 → 30 → 00 → 180.

2. Press **ENTER**.

To cancel the sleep timer:

Press **SLEEP** until it is set to 00.

Adjusting the Sound

Muting the Sound

This is useful during telephone calls or other interruptions.

1. Press **MUTE** to temporarily turn off the sound. While the sound is off, the screen will display the word MUTE.

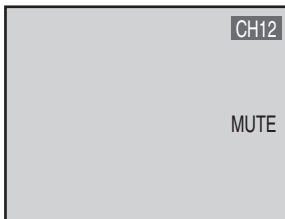

2. To restore the sound, press **MUTE** again or simply press either **VOL** ◀ or **VOL** ▶.

Adjusting the sound quality

You can change the sound quality of your TV by adjusting the bass, treble, and balance.

To adjust the sound quality:

1. Press **MENU**, then press ◀ or ▶ to display the **SOUND** menu.
2. Press ▲ or ▼ to highlight the item you want to adjust.
3. Press ◀ or ▶ to adjust the level.

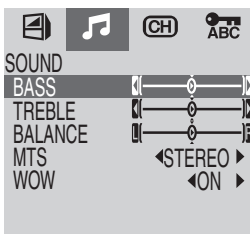

- ◀ makes the sound quality weaker or decreases the balance in the right channel, depending on the item selected.
- ▶ makes the sound quality stronger or decreases the balance in the left channel, depending on the item selected.

Note :

To display the amount of time left until the TV turns off automatically, press **SLEEP** once.

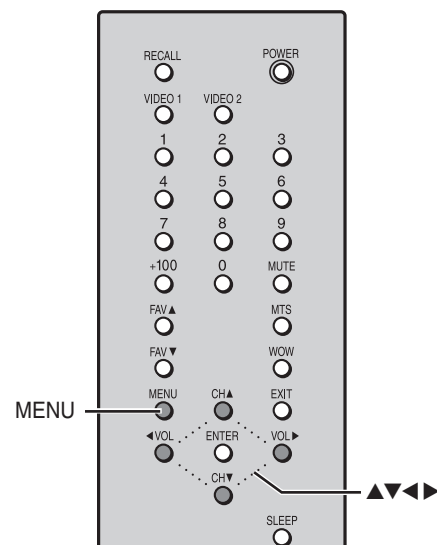
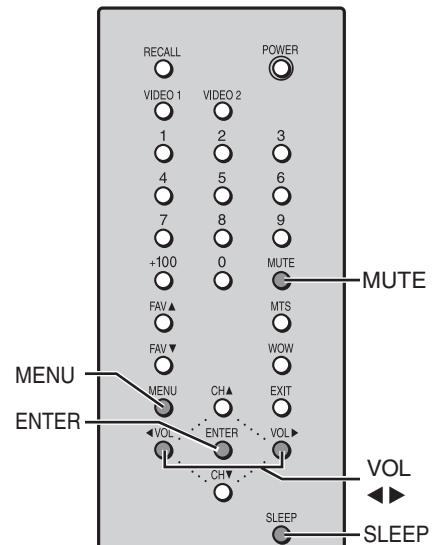

Selecting stereo/SAP broadcasts

The multi-channel TV sound (MTS) feature allows you to listen to high-fidelity stereo sound while watching TV. MTS can also transmit a second audio program (SAP) containing a second language, music, or other audio information (when provided by individual stations).

When the TV receives a stereo or SAP broadcast, the word **STEREO** or **SAP** appears on-screen every time the TV is turned on, the channel is changed, or the **RECALL** button is pressed.



The MTS feature is not available when the TV is in VIDEO mode.

To listen to stereo sound:

- Press **MTS** on the remote control repeatedly until “MTS STEREO” appears on the screen.

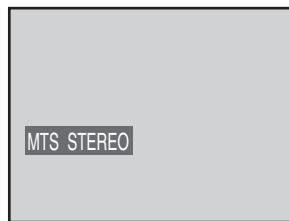

Each time you press the button, Stereo, SAP or Mono mode is selected in order.

You can leave your TV in STEREO mode because it will automatically output the type of sound being broadcast (stereo or monaural).

If the stereo sound is noisy, select MONO to reduce the noise.

To listen to SAP (if available):

Press **MTS** on the remote control until “MTS SAP” appears on the screen.



You will hear the station’s second audio program (if available) from the speakers, while viewing the original program’s picture (see note at right).

You can also select stereo or SAP using the SOUND menu function.

1. Press **MENU**, and then press ◀ or ▶ to display the SOUND menu appears.
2. Press ▲ or ▼ to highlight MTS.
3. Press ◀ or ▶ to select desired mode.

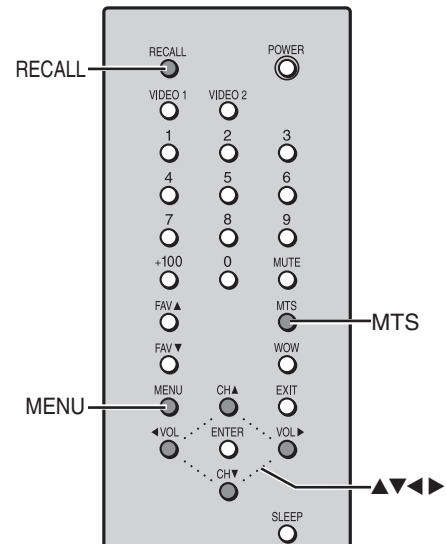
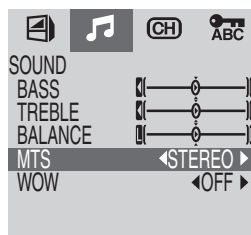

Note :

A second audio program (SAP) can be heard only on those TV stations that offer it.

For example, a station might broadcast music as a second audio program. If you have SAP on, you will see the current program on the screen but hear music instead of the program’s normal audio.

However, if you have SAP on, and the station you are watching is not currently broadcasting a second audio program, you will see the picture but not hear any sound. If this happens, put the TV in STEREO mode so you can hear the station’s normal audio.

Using the WOW (sound effect) feature

WOW is a special combination of SRS audio technologies that creates a thrilling surround sound experience with deep rich bass from a mono or stereo sound sources. Your audio now sounds fuller, richer and wider.

Based on the elements of the flagship SRS 3D technology, WOW restores the spatial cues and ambient information that is lost during standard stereo playback.

To turn the WOW feature on:

Press **WOW** on the remote control to select **WOW** ◀ or ▶ in the **SOUND** menu.

To turn the WOW off press **WOW** again.

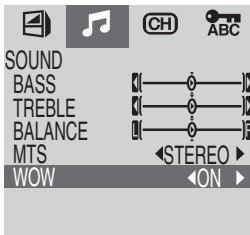

You can also switch the WOW feature on or off using the **SOUND** menu function:

1. Press **MENU**, and then press ◀ or ▶ to display the **SOUND** menu.
2. Press ▲ or ▼ to highlight **WOW** and then press ◀ or ▶ to select "ON" or "OFF".

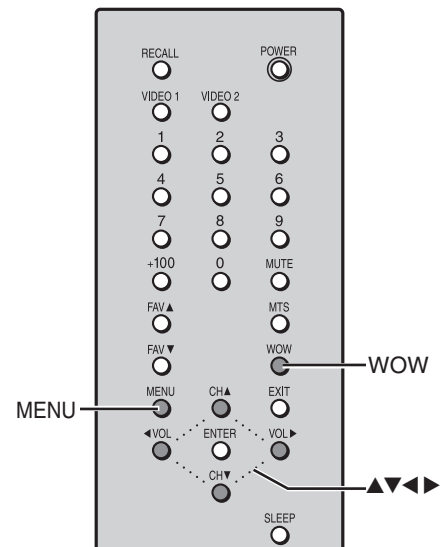
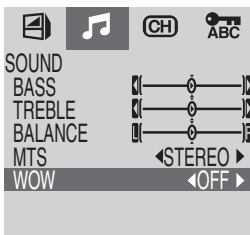

Note:

- SRS WOW, SRS and  symbol are trademarks of SRS Labs, Inc.
- SRS WOW technology is incorporated under license from SRS Labs, Inc.

Displaying on-screen information

Press **RECALL** to display the following information on-screen:

- Channel number or VIDEO mode selected
- Stereo or SAP audio status

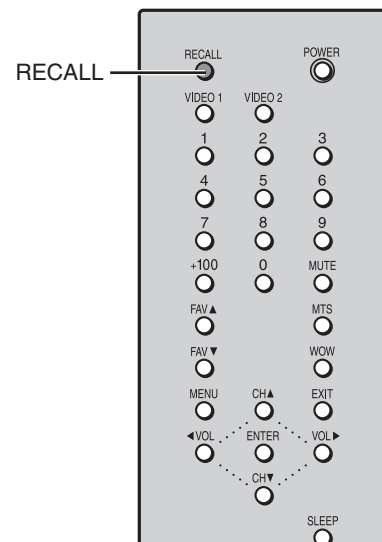

Appendix

Specifications

Receiving System	Antenna input PAL M/N NTSC M
	Video input PAL(50/60 Hz) 3.58 PAL(M/N) NTSC(50/60Hz) 3.58 NTSC
Power Source	110-220 V AC, 50 / 60 Hz DC 16V(TV input)
Power Consumption	14VL43U: 45 W (average) 20VL43U: 60 W (average)
Audio Power	2.5W + 2.5W(10% THD)
Speaker Type	1 - 3/4 inches (45 mm) round
Headphones jack	3.5 mm (stereo-mini type), Impedance 8-32 ohm
Video/Audio Terminals	S-VIDEO INPUT Y: 1 V(p-p), 75 ohm, negative sync. C: 0.286 V(p-p) (burst signal), 75 ohm VIDEO/AUDIO INPUT (1, 2) VIDEO: 1 V(p-p), 75 ohm, negative sync. AUDIO: 150 mV(rms) (Impedance 22k ohm or above) ColorStream® (component video) INPUT Y: 1V(p-p), 75 ohm CB: 0.7 V(p-p), 75 ohm CR: 0.7 V(p-p), 75 ohm AUDIO OUTPUT 150mv(rms)(Impedance 22k ohm or above)
Dimensions	14VL43U: Width 14 - 3/32 inches (358.2 mm) Height 16 - 13/32 inches (416.5 mm) Depth 7.0 inches (177 mm) 20VL43U: Width 19 - 13/32 inches (493 mm) Height 20 - 19/32 inches (523 mm) Depth 7 - 25/32 inches (198 mm)
Mass	14VL43U: 9.1 lbs. (4.15 kg) 20VL43U: 13.9 lbs. (6.3 kg)
Supplied Accessories	Remote Control with 2 size "AAA" batteries Power cord AC adaptor (This AC adaptor can be only used for this LCD TV. Do not use for other apparatus.)

Design and specifications are subject to change without notice.

Troubleshooting

Before calling a service technician, please check the following table for a possible cause of the problem and some solutions.

Problem	Solution
TV will not turn on	<ul style="list-style-type: none">• Make sure the power cord is plugged in, then press POWER.• The remote control batteries may be dead. Replace the batteries.
No picture, no sound	<ul style="list-style-type: none">• Check the antenna/cable connections.
No sound, picture OK	<ul style="list-style-type: none">• The sound may be muted. Press VOLUME (VOL).• The station may have broadcast difficulties. Try another channel.
Poor sound, picture OK	<ul style="list-style-type: none">• The station may have broadcast difficulties. Try another channel.
Poor picture, sound OK	<ul style="list-style-type: none">• Check the antenna connections.• The station may have broadcast difficulties. Try another channel.• Adjust the PICTURE menu.
Poor reception of broadcast channels	<ul style="list-style-type: none">• The station may have broadcast difficulties. Try another channel.• Check the antenna connections.
Cannot receive above channel 13	<ul style="list-style-type: none">• Make sure TV/CABLE is set to CABLE mode.
Black box appears on the screen	<ul style="list-style-type: none">• The closed caption feature may be set to one of the Text modes (T1, T2, T3, or T4). Turn closed captioning OFF.
Unable to select a certain channel	<ul style="list-style-type: none">• The channel may be blocked out with the V-Chip feature, or Erased with the add/erase feature.
Multiple images	<ul style="list-style-type: none">• The station may have broadcast difficulties. Try another channel.• Use a highly directional outdoor antenna.
Poor color or no color	<ul style="list-style-type: none">• The station may have broadcast difficulties. Try another channel.• Adjust the TINT and/or COLOR in the PICTURE menu.
No stereo or SAP sound from a known MTS broadcast	<ul style="list-style-type: none">• Make sure the MTS feature is set properly.
The remote control does not operate	<ul style="list-style-type: none">• There may be an obstruction between the remote control and the remote control sensor.• The remote control batteries may be dead. Replace the batteries.
The V-Chip PIN code does not work	<ul style="list-style-type: none">• Change or reset your PIN code (see page 17 or 20).

Limited United States Warranty

for LCD TV

Toshiba America Consumer Products, Inc. ("TACP") and Toshiba Hawaii, Inc. ("THI") make the following limited warranties to original consumers in the United States.

THESE LIMITED WARRANTIES EXTEND TO THE ORIGINAL CONSUMER PURCHASER OR ANY PERSON RECEIVING THIS LCD TV AS A GIFT FROM THE ORIGINAL CONSUMER PURCHASER AND TO NO OTHER PURCHASER OR TRANSFEREE.

PRODUCTS PURCHASED IN THE U.S.A. AND USED IN CANADA ARE NOT COVERED BY THESE WARRANTIES.

PRODUCTS PURCHASED IN CANADA AND USED IN THE U.S.A. ARE NOT COVERED BY THESE WARRANTIES.

Limited One (1) Year Warranty on Parts and Labor*

TACP/THI warrant this LCD TV and its parts against defects in materials or workmanship for a period of one (1) year after the date of original retail purchase. DURING THIS PERIOD, TACP/THI WILL, AT TACP/THI'S OPTION, REPAIR OR REPLACE A DEFECTIVE PART WITH A NEW OR REFURBISHED PART WITHOUT CHARGE TO YOU FOR PARTS OR LABOR. TACP/THI Authorized Service Station personnel will come to your home when warranty service is required. Depending on the type of repair required, either the service will be performed in your home or the set will be taken to the TACP/THI Authorized Service Station for repair and returned to your home at no cost to you.

Rental Units

The warranty for rental units begins with the date of first rental or thirty (30) days from the date of shipment to the rental firm, whichever comes first.

*Commercial Units

LCD TVs sold and used for commercial purposes have a limited ninety (90) day warranty for all parts, labor.

Owner's Manual and Product Registration Card

Read this owner's manual thoroughly before operating this LCD TV. Complete and mail the enclosed product registration card within ten days after you, or the person who has given you this product as a gift, purchased this LCD TV. Returning the product registration card will enable TACP/THI to provide you with better customer service and improved product support. Failure to return the product registration card will not affect your rights under this warranty.

Your Responsibility

THE ABOVE WARRANTIES ARE SUBJECT TO THE FOLLOWING CONDITIONS:

- (1) You must provide your bill of sale or other proof of purchase.
- (2) All warranty servicing of this LCD TV must be made by an Authorized TACP/THI Service Station.
- (3) The warranties from TACP and THI are effective only if the LCD TV is purchased and operated in the U.S.A. or Puerto Rico.
- (4) Labor service charges for set installation, setup, adjustment of customer controls, and installation or repair of antenna systems are not covered by these warranties. Reception problems caused by inadequate antenna systems are your responsibility.
- (5) Warranties extend only to defects in materials or workmanship as limited above and do not extend to any LCD TV or parts that have been lost or discarded by you or to damage to LCD TV or parts caused by misuse, accident, Acts of God (such as lightning or fluctuations in electric power), improper installation, improper maintenance, or use in violation of instructions furnished by TACP/THI; or to units that have been modified or had the serial number removed, altered, defaced, or rendered illegible.

How to Obtain Warranty Services

If, after following all of the operating instructions in this manual and checking the "Troubleshooting" section, you find that service is needed:

- (1) To find the nearest TACP/THI Authorized Service Station: For LCD TVs purchased in the United States, except Hawaii, visit TACP's web site at www.toshiba.com/tacp, or call toll free 1-800-631-3811. For LCD TVs purchased in Hawaii, contact Toshiba Hawaii, Inc., 327 Kamakee Street, Honolulu, HI 96814, (808) 591-9281.
- (2) Present your bill of sale or other proof of purchase to the Authorized Service Station. Authorized TACP/THI Service Station personnel will come to your home when warranty service is required. Depending on the type of repair required, either the service will be performed in your home or the set will be taken to the Authorized Service Station for repair and returned to your home at no cost to you.

**For additional information, visit TACP's web site:
www.toshiba.com/tacp.**

ALL WARRANTIES IMPLIED BY THE LAW OF ANY STATE OF THE U.S.A., INCLUDING THE IMPLIED WARRANTIES OF MERCHANTABILITY AND FITNESS FOR A PARTICULAR PURPOSE, ARE EXPRESSLY LIMITED TO THE DURATION OF THE LIMITED WARRANTIES SET FORTH ABOVE. WITH THE EXCEPTION OF ANY WARRANTIES IMPLIED BY THE LAW OF ANY STATE OF THE U.S.A. AS HEREBY LIMITED, THE FOREGOING WARRANTY IS EXCLUSIVE AND IN LIEU OF ALL OTHER WARRANTIES, GUARANTEES, AGREEMENTS, AND SIMILAR OBLIGATIONS OF TACP OR THI WITH RESPECT TO THE REPAIR OR REPLACEMENT OF ANY PARTS. IN NO EVENT SHALL TACP OR THI BE LIABLE FOR CONSEQUENTIAL OR INCIDENTAL DAMAGES.

No person, agent, distributor, dealer, or company is authorized to change, modify, or extend the terms of these warranties in any manner whatsoever. The time within which action must be commenced to enforce any obligation of TACP or THI arising under this warranty or under any law of the United States or of any state thereof is hereby limited to 90 days from the date you discover, or should have discovered, the defect. This limitation does not apply to implied warranties arising under the law of any state of the U.S.A.

THIS WARRANTY GIVES YOU SPECIFIC LEGAL RIGHTS, AND YOU MAY ALSO HAVE OTHER RIGHTS, WHICH MAY VARY FROM STATE TO STATE IN THE U.S.A. SOME STATES OF THE U.S.A. DO NOT ALLOW LIMITATIONS ON THE DURATION OF AN IMPLIED WARRANTY, LIMITATIONS ON THE TIME WITHIN WHICH AN ACTION MAY BE BROUGHT, OR THE EXCLUSION OR LIMITATION OF INCIDENTAL OR CONSEQUENTIAL DAMAGES; THEREFORE, THE ABOVE LIMITATIONS OR EXCLUSIONS MAY NOT APPLY TO YOU UNDER SUCH CIRCUMSTANCES.

FST PURE® is a registered trademark of Toshiba America Consumer Products, Inc.

REV. MAR02

E

F

S

Introduction

Connecting your TV

Using the Remote Control

Setting up your TV

Using the TV's Features

Appendix

Index

Limited Canada Warranty

for LCD TV

Toshiba of Canada Limited ("TCL") makes the following limited warranties to original consumers in Canada.

THESE LIMITED WARRANTIES EXTEND TO THE ORIGINAL CONSUMER PURCHASER OR ANY PERSON RECEIVING THIS LCD TV AS A GIFT FROM THE ORIGINAL CONSUMER PURCHASER AND TO NO OTHER PURCHASER OR TRANSFEREE.

PRODUCTS PURCHASED IN THE U.S.A. AND USED IN CANADA ARE NOT COVERED BY THESE WARRANTIES.

PRODUCTS PURCHASED IN CANADA AND USED IN THE U.S.A. ARE NOT COVERED BY THESE WARRANTIES.

Limited One (1) Year Warranty on Parts and Labor*

TCL warrants this LCD TV and its parts against defects in materials or workmanship for a period of one (1) year after the date of original retail purchase. DURING THIS PERIOD, TCL WILL, AT TCL'S OPTION, REPAIR OR REPLACE A DEFECTIVE PART WITH A NEW OR REFURBISHED PART WITHOUT CHARGE TO YOU FOR PARTS OR LABOR. TCL Authorized Service Depot personnel will come to your home when warranty service is required. Depending on the type of repair required, either the service will be performed in your home or the set will be taken to the TCL Authorized Service Depot for repair and returned to your home at no cost to you. IN-HOME SERVICE ONLY APPLIES WITHIN 100 KILOMETERS OF AN AUTHORIZED TCL SERVICE DEPOT.

Rental Units

The warranty for rental units begins with the date of first rental or thirty (30) days from the date of shipment to the rental firm, whichever comes first.

*Commercial Units

LCD TVs sold and used for commercial purposes have a limited ninety (90) day warranty for all parts, labor.

Owner's Manual

Read this owner's manual thoroughly before operating this LCD TV.

Your Responsibility

THE ABOVE WARRANTIES ARE SUBJECT TO THE FOLLOWING CONDITIONS:

- (1) You must provide your bill of sale or other proof of purchase.
- (2) All warranty servicing of this LCD TV must be made by an Authorized TCL Service Depot.
- (3) The warranties from TCL are effective only if the LCD TV is purchased in Canada from an authorized TCL dealer and operated in Canada.
- (4) Labor service charges for set installation, setup, adjustment of customer controls, and installation or repair of antenna systems are not covered by these warranties. Reception problems caused by inadequate antenna systems are your responsibility.
- (5) Warranties extend only to defects in materials or workmanship as limited above and do not extend to any LCD TV or parts that have been lost or discarded by you or to damage to LCD TV or parts caused by misuse, accident, Acts of God (such as lightning or fluctuations in electric power), improper installation, improper maintenance, or use in violation of instructions furnished by TCL; or to units that have been modified or had the serial number removed, altered, defaced, or rendered illegible.

How to Obtain Warranty Services

If, after following all of the operating instructions in this manual and checking the "Troubleshooting" section, you find that service is needed:

- (1) To find the nearest TCL Authorized Service Depot, visit TCL's web site: www.toshiba.ca.
- (2) Present your bill of sale or other proof of purchase to the Authorized Service Depot. Authorized TCL Service Depot personnel will come to your home when warranty service is required. Depending on the type of repair required, either the service will be performed in your home or the set will be taken to the Authorized Service Depot for repair and returned to your home at no cost to you. IN-HOME SERVICE ONLY APPLIES WITHIN 100 KILOMETERS OF AN AUTHORIZED TCL SERVICE DEPOT.

**For additional information, visit TCL's web site:
www.toshiba.ca**

ALL WARRANTIES IMPLIED BY THE LAW OF ANY PROVINCE OF CANADA, INCLUDING THE IMPLIED WARRANTIES OF MERCHANTABILITY AND FITNESS FOR A PARTICULAR PURPOSE, ARE EXPRESSLY LIMITED TO THE DURATION OF THE LIMITED WARRANTIES SET FORTH ABOVE. WITH THE EXCEPTION OF ANY WARRANTIES IMPLIED BY THE LAW OF ANY PROVINCE OF CANADA AS HEREBY LIMITED, THE FOREGOING WARRANTY IS EXCLUSIVE AND IN LIEU OF ALL OTHER WARRANTIES, GUARANTEES, AGREEMENTS, AND SIMILAR OBLIGATIONS OF TCL WITH RESPECT TO THE REPAIR OR REPLACEMENT OF ANY PARTS. IN NO EVENT SHALL TCL BE LIABLE FOR CONSEQUENTIAL OR INCIDENTAL DAMAGES.

No person, agent, distributor, dealer, or company is authorized to change, modify, or extend the terms of these warranties in any manner whatsoever. The time within which action must be commenced to enforce any obligation of TCL arising under this warranty or under any law of Canada or of any province thereof, is hereby limited to 90 days from the date you discover, or should have discovered, the defect. This limitation does not apply to implied warranties arising under the law of any province of Canada.

THIS WARRANTY GIVES YOU SPECIFIC LEGAL RIGHTS, AND YOU MAY ALSO HAVE OTHER RIGHTS, WHICH MAY VARY FROM PROVINCE TO PROVINCE IN CANADA. SOME PROVINCES OF CANADA DO NOT ALLOW LIMITATIONS ON THE DURATION OF AN IMPLIED WARRANTY, LIMITATIONS ON THE TIME WITHIN WHICH AN ACTION MAY BE BROUGHT, OR THE EXCLUSION OR LIMITATION OF INCIDENTAL OR CONSEQUENTIAL DAMAGES; THEREFORE, THE ABOVE LIMITATIONS OR EXCLUSIONS MAY NOT APPLY TO YOU UNDER SUCH CIRCUMSTANCES.

FST PURE® is a registered trademark of Toshiba America Consumer Products, Inc.

REV. MAR02

Index

A

AC adaptor connection	7
A/V cables (standard)	7
Antenna cables (coaxial)	7
Audio amplifier connection	11
Auto power off	22

B

Back of the TV	6
Blue screen	21

C

Cable converter box connection	8
Camcorder connection	11
CH ▲▼ buttons	14
Channel Number buttons	14
Channel programming	
ADD/ERASE	15
Automatic programming	14
TV/CABLE selection	14
Closed caption	23
Color adjusting	21

D E

DVD connection	9, 10
EXEMPTIONS	2
EXIT button	13

F I

FAV ▼▲ buttons	16
Favorite channels	16
Front of the TV	6
INVERT	22

L M

Language selection	14
Menu system	13
MTS feature	25
MUTE button	24

P

Picture adjustments	
COLOR	21
Picture quality	21
Power cord connection	7

R

RECALL button	26
Remote control	
Battery installation	12
Learning about the buttons	12

S

Safety instructions	3
SAP sound	25
Satellite receiver connection	9
SLEEP button	24
Sleep timer	24
Sound quality adjustments	24
Specifications	27
Stereo sound	25
S-video cable	7
System	14

T

Troubleshooting	28
TV/VIDEO button	22

V

V-CHI P	
CHAGING PIN	20
MPAA RATING	18
V-CHIP LOCK	18
VCR connection	8-10

W

Warranty	29, 30
WOW feature	26

TOSHIBA AMERICA CONSUMER PRODUCTS, INC.

HEAD OFFICE: 82 TOTOWA ROAD, WAYNE, NJ 07470, U.S.A.

NATIONAL SERVICE DIVISION: 1420-B TOSHIBA DRIVE, LEBANON, TN 37087, U.S.A.

TOSHIBA HAWAII, INC.

HEAD OFFICE: 327 KAMAKEE STREET, HONOLULU, HI 96814, U.S.A. – TEL: (808) 591-9281

TOSHIBA OF CANADA LTD.

HEAD OFFICE: 191 McNABB STREET, MARKHAM, ONTARIO, L3R 8H2, CANADA – TEL: (905) 470-5400

SERVICE CENTERS:

TORONTO: 191 McNABB STREET, MARKHAM, ONTARIO L3R 8H2, CANADA – TEL: (905) 470-5400

MONTREAL: 1643 NORTH SERVICE RD., TRANS-CANADA HIGHWAY, DORVAL QUEBEC, H9P 1J1, CANADA
– TEL: (514) 856-4100

VANCOUVER: 22171 FRASERWOOD WAY, RICHMOND, B.C., V6W 1J5, CANADA – TEL: (604) 303-2500

MANUFACTURED BY

TOSHIBA VISUAL-EQUIPMENT CORPORATION

ColorStream is registered trademarks of Toshiba America Consumer Products, Inc.

TOSHIBA

23565947